

Motion Sensor User Guide

The motion sensor detects indoor movement. The sensor transmits a signal to the Noah hub when movement has been detected

Features

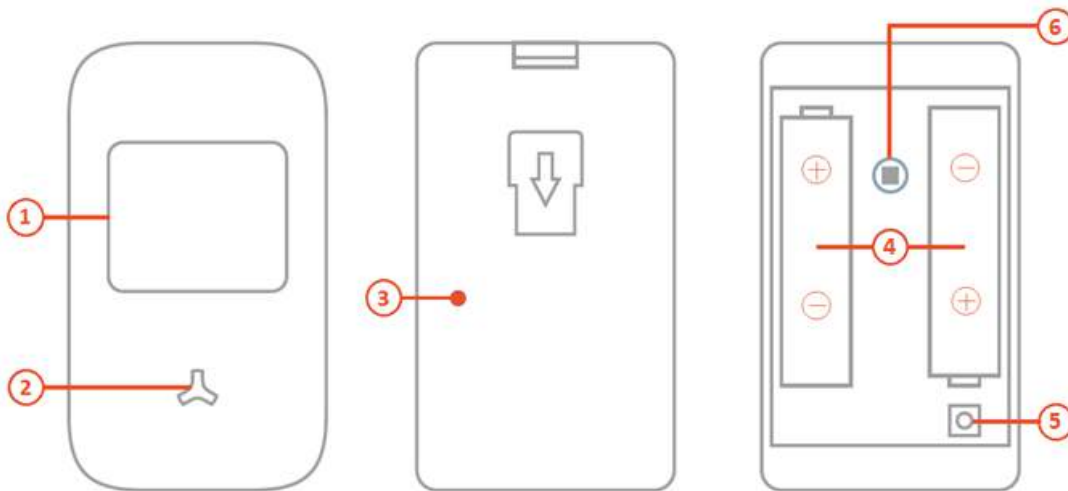

- 1. PIR Sensor
- 2. LED Indicator
- 3. Pairing Button

- 4. Battery Compartment
- 5. Tamper Switch
- 6. Infrared Sensor

Working Status

In **Normal mode**, the sensor detects motion constantly, but will only trigger the alarm on the first detection. After four minutes of **no activity**, the sensor will reset ready to trigger the alarm.



Red LED flashes once

New movement has been detected. Alarm will be triggered if Noah is armed.

Pairing the motion sensor to the Noah Hub

You will need the following to pair the siren to the Noah hub.

- Motion sensor
- Noah hub
- Remote Control (provided with the Noah hub)
- Clan at Home app on your smartphone

1. Open the back cover of the sensor by pressing down on the clip at the top of the sensor and pulling away



2. Check that the battery is fitted properly into the compartment and remove any battery tabs. The sensor will make a beeping sound once it has powered up.

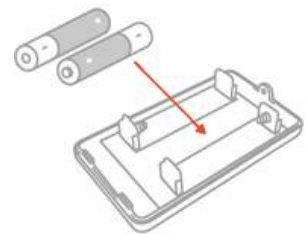

3. Place the cover back on and close tightly

4. Secure the cover with the provided security screw

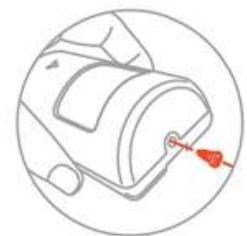

5. Open the Clan at Home app on your smartphone or tablet

6. Click Noah Alarm System

7. Press the  icon to enter the accessories menu

8. Press the (+Add) icon. The Noah hub LED will turn purple when it is ready for pairing.

9. Then press the pairing button at the back of the sensor.
The Noah hub will flash green once and make a beep sound when it has paired successfully.

Test Mode: Once the motion sensor has been paired to the Noah hub, it will automatically enter into Test Mode.

The sensor will detect each movement and trigger the alarm.

After 20 detections, the sensor will enter into Sleep Mode. This will enable you to install the sensor without triggering the alarm.

Installation

The Motion sensor should be installed close to an entrance or exit. It is most sensitive to cross-movement, this is when a person walks past the sensor rather than directly towards it.

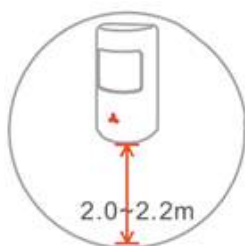
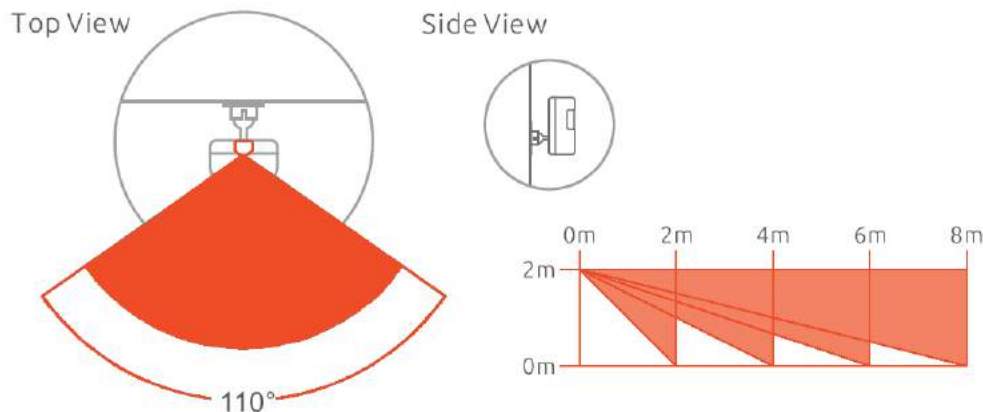

Use the provided screws to fix the bracket on to the wall, then attach the sensor to the bracket. Ensure the sensor is around 2 metres from the ground

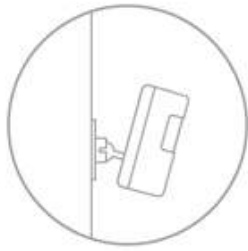

Adjust the angle of the sensor to the best suited position

Walk Test: Arm Noah then wait four minutes until the sensor has entered Normal Mode, then walk across the detection area and watch the LED indicator – it will flash once and trigger the alarm.

Please note:

Avoid mounting the detector close to heaters, radiators or air conditioning units

Avoid facing the sensors towards windows which could interfere with the infrared

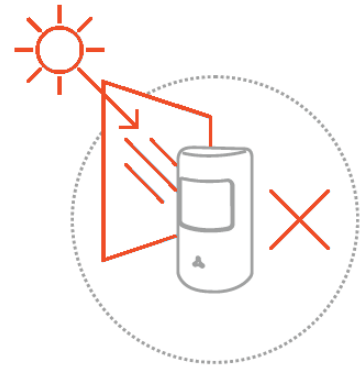

Specification

Power supply: DC 3V/2pcs AA batteries

Standby current: $\leq 80\mu\text{A}$

Alarm current: $\leq 12\text{mA}$

Detection Area: 7-8m/110°

Transmitting distance: <80m (in open area)

Wireless RF frequency: 315Mhz/433MHz

Working temperature: -10°C - 55°C

Detector dimension (L/W/H): 90 x 52 x 36.5 mm

Bracket dimension (L/W/H): 48 x 26 x 29 mm